

The **MobilSwitch-5ad** GSM device is developed for industrial signaling and remote controlling purposes. The analog input of the device can measure between 15V or 30V, the pulse-counter input can count up to 199'999. The device is equipped with 4 digital voltageless input contacts. It has 4 low voltage relay outputs. With the included software the module can be programmed with PC-s and laptops. The user get messages about the input changes via user-defined SMS-s. The outputs can be controlled by user-programmed SMS-s and by free voice calls based on caller ID. The device can be programmed for 8 telephone numbers; therefore it can send SMS-s up to 8 different phone numbers. The module can operate as a stand-alone GSM dialer,



GSM controller or remote controller; and it can be used for remotely monitoring and controlling industrial machines, equipment and devices. The supply voltage level of the device is within the range of industry standards (10-30V) and it draws maximum 500mA current. The device is equipped with a unique name and identifier. All of the inputs (4+2+1) can be labeled up to 16-character long names. The SMS notifications sent by the device contain these labels, moreover the output on/off commands can be also defined by the user. The output relays can be programmed to be either monostable (i.e. after switching the output on, it will be automatically switched off after a defined time duration) or bistable (switching the output on and off requires separate commands). In monostable output mode, the outputs can be switched via voice calls and the switched-on state of the outputs can be configured up to 9999 seconds (~3 hours) of duration. As the configured time elapsed, the relays will be switched off automatically and the outputs return to their default states. For each telephone number, the user can select

and configure which input changes can generate alerts and notifications for the corresponding number that can be contacted via SMS and/or voice calls. The device can be equipped either with smaller, rectangular dual-band stick antenna or with magnetic, screwable external antenna equipped with RG174 SMA-connector.

### 1. Operation of the GSM device:

The **MobilSwitch-5ad** signaling and remote control module can operate on any provider's network with a microSIM card (either works with subscription or with pre-paid card) which is not protected with PIN code. After switching on the device, it searches and registers for its provider's cellular network and initializes its configuration parameters which can be downloaded into the device memory with the provided configurator software. The device keeps its configuration state and values after shutdown, including input names, output states, etc.; and it continues its operation after power-on. The **MobilSwitch-5ad** variant is equipped with a black aluminium enclosure with unlocked GSM module, and delivered with 1000mAh internal Lythium-Polimer battery, GSM antenna and the configurator software. The module also can be ordered with external magnetic antenna.



The **MobilSwitch-5c** module variant is the flagship device of the **MobilSwitch** family, however the simplified **MobilSwitch-5ad**, **MobilSwitch-5d**, **MobilSwitch-3** and **MobilSwitch-2** devices with less inputs and features and without internal battery can also be purchased.

## 2. Explanation status of LEDs on top side

The colorful LEDs located beneath the front cover indicate the status of the device. The lower, bi-color LED labeled as “Hbit” can express statuses and messages explained below, and the upper, yellow LED labeled as “SMS” indicates the SMS and voice:

<b>Bi-color LED states:</b>	
Continuously yellow:	The GSM modem is initializing itself, searching for network. This state lasts for 30-40 seconds after power-on.
	The GSM modem is busy, sending receiving SMS or a phone call
Blinking green	“Heartbeat” (indicates signal strength): The green blinking refers to the strength of cellular signal. Less-frequent blinking indicates weaker signal, more frequent blinking refers to stronger signal; according to the followings:
	1 blink, pause:      weak signal; the device might completely lose signal and disconnect from network. It is worth to consider re-locating the device.
	2 blinks, pause:      weak signal; the device can restart which results in ~30 seconds of outage in operation.
	3 blinks, pause:      moderate signal; the device can operate stable.
	4 blinks, pause:      strong signal; the device can operate stable.
	5 blinks, pause:      maximum signal strength, the device can operate stable.
Red-green fast blinking:	<ul style="list-style-type: none"> <li>- the GSM module cannot find network, or</li> <li>- the signal strength is not enough for operation, or</li> <li>- faulty antenna, or</li> <li>- SIM card error, or the SIM card is not entitled for voice calls, or</li> <li>- SIM card is locked with PIN code</li> </ul>
<b>Yellow LED states:</b>	
Continuously:	This LED is on when the device is sending/receiving SMS-s, initiating voice calls or the user is calling the device.
Blinking:	This LED is blinking during the downloading or reading procedure.

## 3. Module wiring and connectivity:

A “Test” button and a red jumper are located on the top of the device. When the jumper is connected, the device operates from the internal battery which is located in the body of the device. During power-outage, the internal battery can provide 6-8 hours of continuous operation. The battery is connected to the panel with a white-colored connector. The wiring of the panel is explained in the connection figure. The power supply voltage should be connected to the leftmost red socket located on the panel. The supply voltage have to be between 10-30V DC, and the supply must tolerate 500mA of current draw.

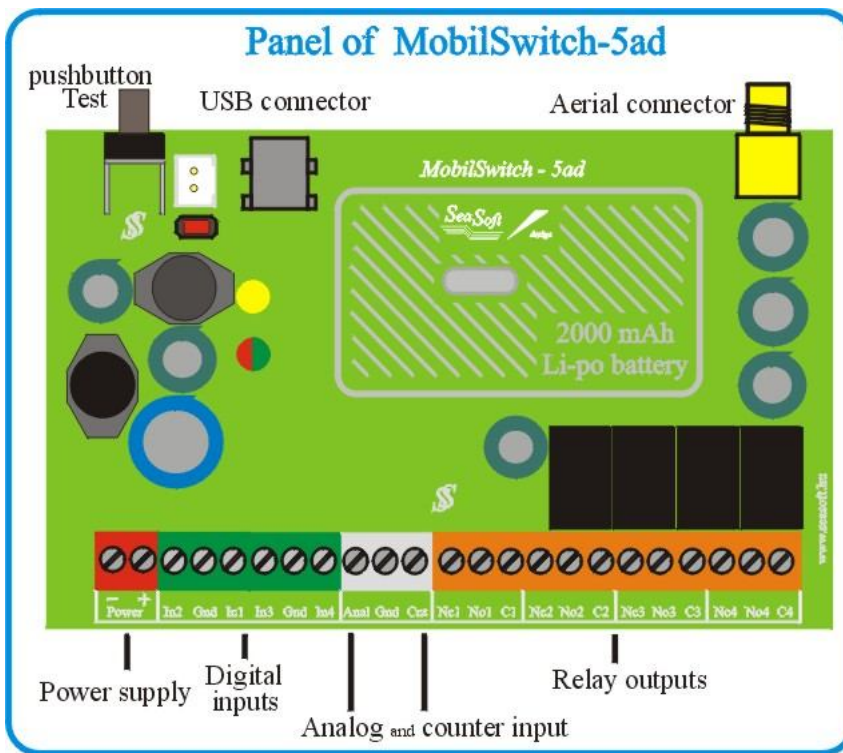

The mini-USB connector that is used for configuration is located on the upper side of the panel. The microSIM card must be inserted into the holder as explained in the corresponding figure. The low voltage low current “No-Com-Nc” type relays are located on the bottom of the panel and the loads connected to the relays must not draw more than 1A current at 48V. There are terminals for each pin of the relays. The GSM modem has an external SMA connector, thus not only the rectangular stick antenna, but also the external magnetic-bottom antenna with coax cord can be connected, therefore the device can be placed inside of a metal case or in a metal house of controller and the antenna can be placed outside to achieve better signal strength.

The 4 digital inputs, the analog input and the input of the counter are located at the bottom of the panel. The digital inputs can be only voltageless type inputs. The analog inputs can sense 5-30Vdc. The counter is also voltageless type input can count up to 199'999 and it resets in the case of an alarm. Moreover, the counter value can be reset remotely via SMS. This input can only recognize pulses with lower frequency of 100Hz (10ms), and all pulses with higher frequency of 100Hz are considered as noise. The analog input can sense voltage levels between 0-15V or 0-30V DC. The simple voltageless input can be triggered by 0V, i.e. by pulling the input to GND (ground) via conductors or semi-conductors. Only the input that pulled to 0V counts as active state. External voltage must not be applied to this type of input. The module is able to sense the outage of power supply. Because of the EMC and line filtering, the sensing and delay takes few seconds of time.

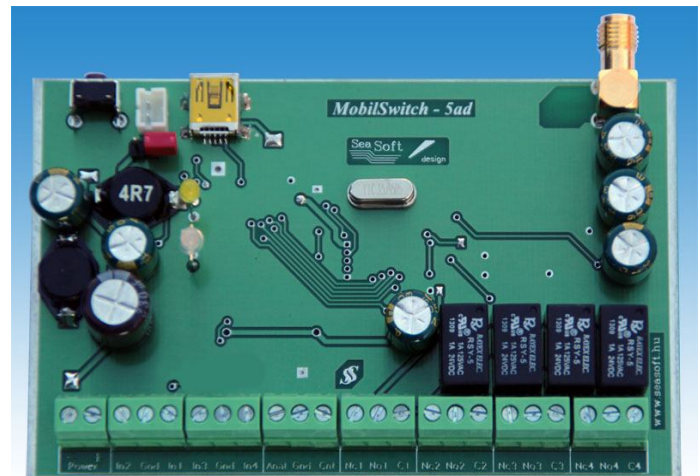

The power supply input is protected against reverse polarity, and the **MobilSwitch-5ad** module is protected with a 500mA self-resetting fuse. The device supplied from its USB port alone is only capable of configuring operations, and supplying with USB alone does not provide enough current for stable operation. On the upper board is a "Test" button. Pushing that button the module can send a report SMS with the status of inputs and outputs. The red jumper in "On" position can connect the Li-Po battery. In case of supply error it can ensure an alarm message and 6-8 hours battery supplied working time.

#### 4. Programming and configuring the device from PC or laptop:

The **MobilSwitch-5ad** signaling module can be programmed via USB with the included software. After connecting the device to the power source, it should be connected to the PC via USB. The device driver must be installed first, therefore the operating system (Windows XP, 7, 8) can recognize the connected module. In the case that the driver is already installed but the operating system still cannot recognize the device, the



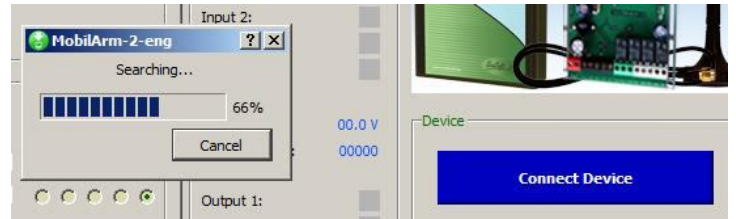
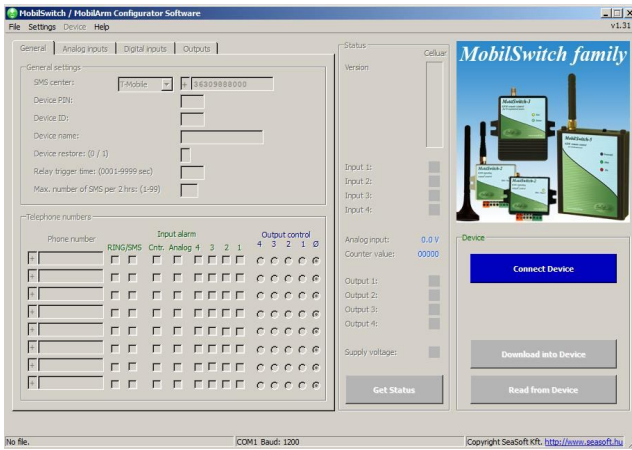

operating system settings should be modified in that particular order as described in the appendix. The software can configure all members of the MobilSwitch family. After connecting the device, launching the software and pressing the “Connect Device” button, the software will automatically search and recognize the

connected device. After successful recognition, the corresponding picture of the device will be displayed in the main window of the software. The status of the device can be queried by pressing the “Get Status” button if the device is connected to a network. After connecting the signaling and remote control device and querying its status, the user interface is represented as the followings:

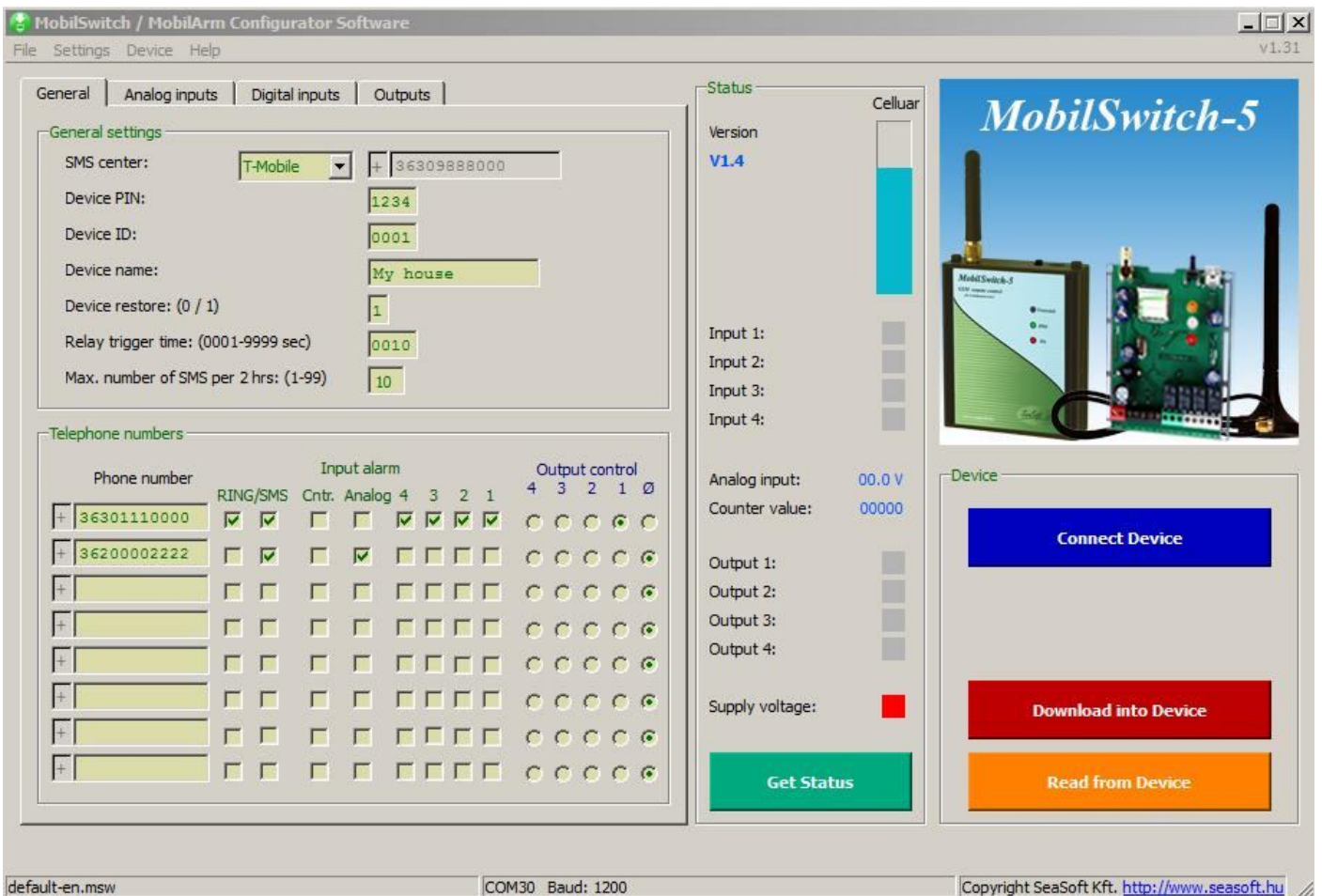

The user settings can be performed by filling the appropriate input fields. All major inputs that are enabled for editing must be filled, except the telephone numbers, however at least one number must be set. The first telephone number has higher rank among the others: every incoming SMS that the device cannot recognize (e.g. SMS-s from the carrier) is forwarded to this number. If this feature is not needed, this field can be left blank thus the unrecognized SMS-s will not be forwarded. With the checkboxes located next to the phone numbers, the user can specify which input alert or alerts should be sent to the telephone number via SMS. Moreover, the user can set within the RING column whether the device should initiate a voice call to the corresponding numbers after sending SMS in the case of an alert. It can also be set with the Output Control columns which output should be triggered when there is an incoming phone call originated from the given phone number to the device. Issuing notifications about analog input and counter input alerts is optional. The input fields must be set carefully according to their proper format, and characters with accents are not

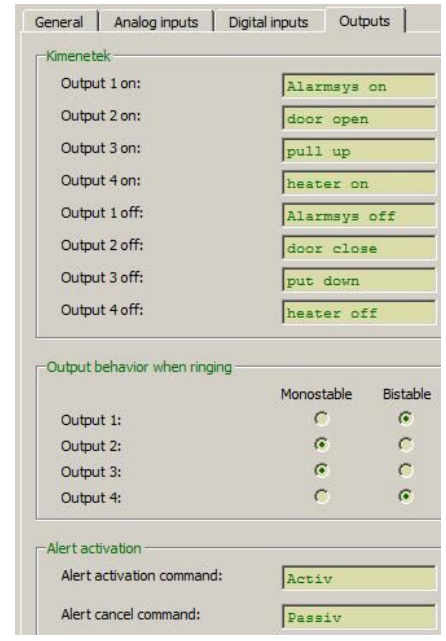
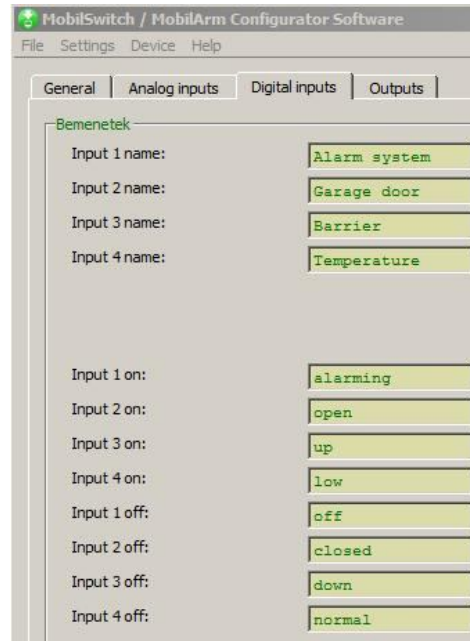
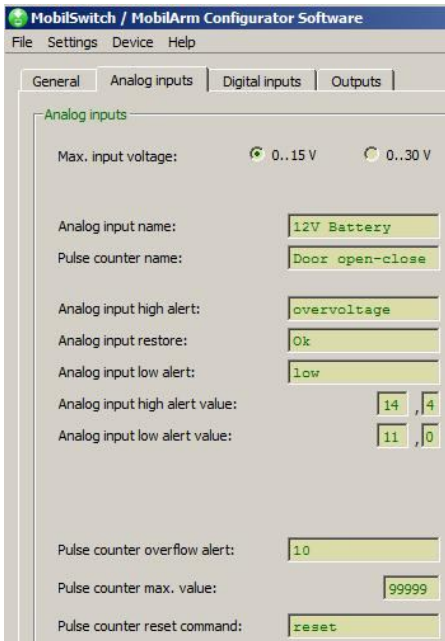

allowed. All telephone numbers must be given in the international telephone number format. On the “Digital Inputs” tab, the labels of inputs and the corresponding messages that are sent via SMS in the case of input change can be set. The settings and values of the analog and counter inputs can be set on the “Analog Inputs” tab. The range of the analog input can be selected (0-15V or 0-30V), and the minimum and maximum values can be set. The pulse counter issues an alert when the counter reaches the given maximum value. After sending an alert, the counter resets, however resetting the counter can be performed remotely with a command via SMS too. This command can be set on this tab as well. On the “Outputs” tab, the output commands can be specified. These commands are sent to the device via SMS and after reception, the device will switch the output states accordingly. All outputs can operate in both monostable and bistable modes in the case of an incoming voice call. The settings related to this feature can also be set on this tab. The device can be set in passive mode with the appropriate command. In passive mode, the device does not send alerts, however it stays online therefore it can be controlled remotely. The device returns to active mode upon receiving an active-mode command. With the software, the configuration data can be downloaded into and

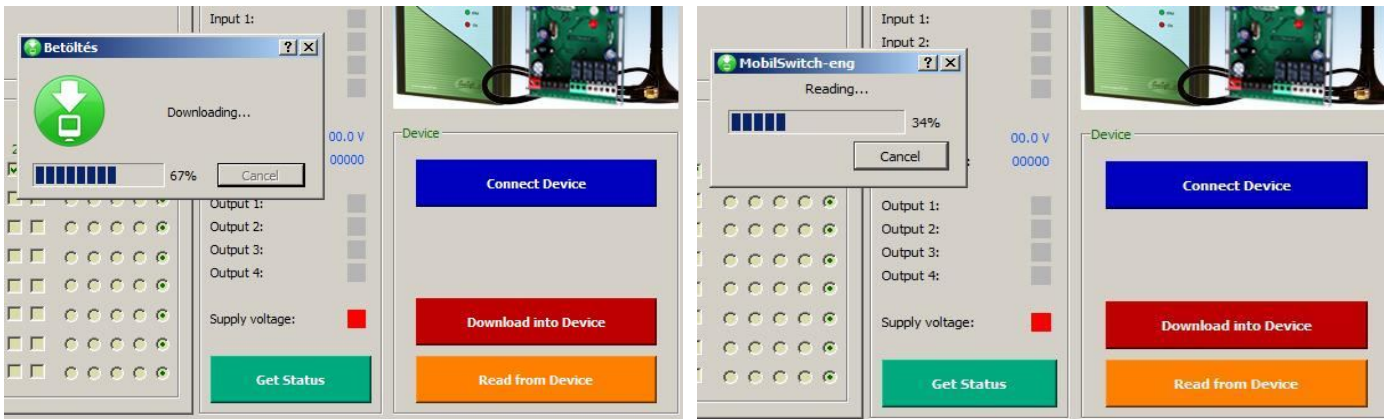

read from the device. During downloading and reading operations, the user can track the progress with the progress-bar displayed in the pop-up window. In case of encountering an error, the user is notified in the pop-up window. The current configuration can be saved to a file for further validation, and these files can be opened with the software.

## 5. SMS commands:

The module can receive and execute various pre-defined commands. These commands are described in the followings:

- **Query SMS command:** **#R**

**Response SMS: 0001 My house Out:0000 In:0000 An:00.0V Cntr:00000 Power:1 Act V1.4**

where:	<b>0001</b>	- device ID
	<b>My house</b>	- device name
	<b>Out:0000</b>	- the status of outputs
	<b>In:0000</b>	- the status of inputs
	<b>An:00.0V</b>	- current voltage on analog input
	<b>Cntr:00000</b>	- current value of digital counter
	<b>Power:1</b>	- input power is good
	<b>Act</b>	- modul is in active status
	<b>V1.4</b>	- GSM module's firmware version

- **Output setting command:** **#Alarmsys on**

**Response SMS: 0001 My house Out:1000 In:0000 An:00.0V Cntr:00000 Power:1 Act V1.4**

where:	<b>Out:1000</b>	- Output-1 relay is in ON status (Alarmsys device)
--------	-----------------	--

- **Alert activation command:** **#Active**

where:	<b>#Active</b>	- The module is in Active status, in case of changes it can signaling and can send messages
--------	----------------	---

- **Alert deactivation command :** **#Passive**

where:	<b>#Passive</b>	- The module is in Passive status, in case of changes it will stay in sleep mode
--------	-----------------	--

- **Counter reset command:** **#Reset**

where:	<b>#Reset</b>	- Resets the counter to 00000
--------	---------------	-------------------------------

- **Device reset command:** **#X**

where:	<b>#X</b>	- The modul will completely resets itself, will completely clear its memory and will restart itself. Module requires a new configuration to download
--------	-----------	--

Please note that the device can only execute the command sent via SMS, if the received command is literally the same as the command in the device memory. If the received command is not the same, the command will not be executed, and the command is forwarded to the first telephone number (in case that number is valid and specified in the memory). The restart command will result in a device restart, and all timers will be cleared, moreover all outputs will return to default state. Alarms that were set previously will be cleared. All other configuration data will be retained according to the last configuration. In the case a relay was set to bistable mode and it was set as active, then the relay will be set active and will remain active after reset.

## 6. Modifying the configuration via SMS commands:

All of the configuration data can be remotely modified with SMS commands. Reprogramming via SMS requires full attention, because a wrongly formatted SMS command might result in unwanted operation. In this case the device might not be reached and programmed remotely and the module can be re-programmed only via USB. After receiving a command, the module acknowledges the command via an SMS. The next command must not be sent to the device without receiving the acknowledgement. The acknowledgement SMS contains the modified parameter. Wrong commands are not interpreted and the device and replies with an “error” SMS. The full memory map is essential on order to re-program the device remotely.

<i>MobilSwitch-5ad memory map</i>			
Memory loc.	Function of memory	Remarks	Factory settings
00	Sms call center	International format	36309888000
01	Device PIN code	4 digit	1234
02	Device identifier	4 digit	0001
03	Device name	Max. 16 characters	My house
04	Restore report (of digital inputs)	0 = no, 1 = yes	1
05	Relay hold time	From 0 to 9999 sec	0010
06	Max. number of SMS (per 2 hours)	0 ... 99	10
07	Activated outputs (in case of dial)	monostable=1 bistable=0	1000
08	Analog input 1 (low value in Volts)	0 ... 9.9	11.0
09	Analog input 1 (high value in Volts)	0 ... 9.9	14.4
10	Analog measuring range	0 = 0...15V 1 = 0...30V	0
11	Counter alarm value	00000 ... 99999	10
12...15	Not used	-----	-----
16	Anal. Input 1 low level alarm message	Max. 16 karakter	low
17	Anal. Input 1 high evel alarm message	Max. 16 karakter	overvoltage
18	Anal. Input 1 - alarm restoral message	Max. 16 characters	Ok
19	Alarm message of counter overflow	Max. 16 karakter	oweflow
20 ... 21	Not used	-----	-----
22	Name of Analog Inpout 1	Max. 16 characters	12V Battery
23	Name of Counter	Max. 16 characters	Door open-close
24	Name of Digital Inpout 1	Max. 16 characters	Alarm system
25	Name of Digital Inpout 2	Max. 16 characters	Garage door
26	Name of Digital Inpout 3	Max. 16 characters	Barrier
27	Name of Digital Inpout 4	Max. 16 characters	Temperature
28	Digit. Input 1 - alarm message	Max. 16 characters	alarming
29	Digit. Input 2 - alarm message	Max. 16 characters	open
30	Digit. Input 3 - alarm message	Max. 16 characters	up
31	Digit. Input 4 - alarm message	Max. 16 characters	low
32	Digit. Input 1 - restoral message	Max. 16 characters	off
33	Digit. Input 2 - restoral message	Max. 16 characters	closed
34	Digit. Input 3 - restoral message	Max. 16 characters	down
35	Digit. Input 4 - restoral message	Max. 16 characters	normal



<i>MobilSwitch-5ad memory map (continued)</i>			
Memory loc.	Function of memory	Remarks	Factory settings
36	Relay 1 – Switch ON command text	Max. 16 characters	Alarmsys on
37	Relay 2 – Switch ON command text	Max. 16 characters	door open
38	Relay 3 – Switch ON command text	Max. 16 characters	pull up
39	Relay 4 – Switch ON command text	Max. 16 characters	heater on
40	Relay 1 – Switch OFF command text	Max. 16 characters	Alarmsys off
41	Relay 2 – Switch OFF command text	Max. 16 characters	door close
42	Relay 3 – Switch OFF command text	Max. 16 characters	put down
43	Relay 4 – Switch OFF command text	Max. 16 characters	heater off
44	Counter reset command	Max. 16 characters	Clear
45	Alert activation command	Max. 16 characters	Activ
46	Alert de-activation command	Max. 16 characters	Passiv
47	Not used	----	----
48	1 <sup>st</sup> phone number	International format	36301111000
49	2 <sup>nd</sup> phone number	International format	36200002222
50	3 <sup>rd</sup> phone number	International format	----
51	4 <sup>th</sup> st phone number	International format	----
52	5 <sup>th</sup> phone number	International format	----
53	6 <sup>th</sup> phone number	International format	----
54	7 <sup>th</sup> phone number	International format	----
55	8 <sup>th</sup> phone number	International format	----

Based on the two upper tables and with great attention to the appropriate programming format, every memory block can be re-programmed with SMS commands. During remote programming, the untouched memory blocks will keep their original data programmed via USB. Programming the device via SMS-s requires a fair amount of time, therefore this programming method is only advised for occasional remote modifications. Therefore, to fully configure the device, it is advised to program it via USB.

The reading memory commands and the general query commands are the simplest:

**!1234,R00** - **R**(eading the memory)**00** - returns provider's SMS center number

Response SMS: - **0001 My house R00: 36309888000**

**!1234,R28** - **R**(eading the memory)**28** - returns the message of Input-1

Response SMS: - **0001 My house R28: alarming**

**!1234,R** - **R**(eading the general status) - it is a general query command without memory index

Response SMS: - **0001 My house Out:1000 In:0000 An:00.0V Cntr:00000 Power:1 Act V1.4**



Memory registers are also writeable by the (**W**) command:

**!1234,W00,36309888000** where: **1234** PIN code of module  
**W00** pointing to its memory register  
**36309888000** provider's SMS center number (here: hungarian T-Mobil)

**!1234,W01,5678** where: **1234** the old PIN code of module  
**W01** pointing to its memory register  
**5678** the new PIN code of module

**!1234,W36,Door open** where: **Door open** the new switch-off command of relay output-1  
**W36** its memory register where the command is stored

A complex command: changing telephone number and behaviors:

**!1234,W48,1100001,3,36305556666** where:  
**W48** memory location of 1st phone number  
**11010101** - behavior of modul in case of this phone number and the meanings of characters in order:  
**Ring** - in case of **1** it will ring this phone number  
**Cntr** - in case of **1** counter will give alarm for this phone number  
**A** - in case of **0** analog input will not give alarm for this phone number  
**0101** - digital inputs give alarm for this phone number as described by the digits  
**3** - digit **3** means the number of output to control in case of a simple phone call  
**36305556666** - the new phone number

## 6. Other facts:

Regarding to the device functionality, GSM networks and the specialty of GSM voice calls and SMS-s, the module requires further remarks:

- a) The device can be operated with any microSIM card
- b) The received unknown SMS-s, including the ones sent from the carrier (including the balance check SMS) are forwarded to the first telephone number, if the first telephone number is specified in the configuration.
- c) If a pre-paid SIM card is used and the balance reaches zero, the device can remain operational however it cannot send further SMS-s or initiate calls. In this case it is advised to regularly check the balance of the card.
- d) After downloading a configuration from PC via USB, the device will restart which takes 30-40 seconds, and it will be operational after registering to a GSM network.
- e) All members of the **MobilSwitch** family can operate only with SIM cards that are not protected with PIN codes. Please note that the SIM PIN is not equal to the module PIN number.
- f) Before device use, the PIN code has to be removed from the SIM card.
- g) By using pre-paid SIM card, showing the caller ID must be enabled. This can be performed by contacting the carrier's customer service.
- h) Call-forwarding and SMS reminders about missed calls sent by the carrier must be disabled on the SIM card.

## 7. Installation guide:

During *MobilSwitch-5ad* device installation, the tasks are advised to be performed in the following order:

1. The SIM PIN must be disabled on the SIM card, then it is advised to put the SIM card in a regular mobile phone to check if the SIM card is allowed to send SMS-s. Newly bought SIM cards has to be checked whether it can send SMS-s. (Sometimes the initial balance of specific SIM cards can be only used for voice calls. In this case the card has to be topped-up by the user to be able to send SMS-s.) Considering pre-paid SIM cards, showing the caller ID feature must be enabled through customer service. Setting or checking the state of this feature cannot be performed with a regular mobile phone.
2. After programming the device, the SIM card should be inserted into the SIM holder as shown in the figure. The SIM holder is located on the front of the device.
3. The power supply must be connected with correct polarity. After powering on, the device should be waited for registering to a GSM network. This is indicated with green-colored blinking of the LED
4. The configurator software can be installed from the CD or can be downloaded from <http://www.seasoft.hu> webpage. First the device driver must be installed. It is advised to restart the computer after driver installation.
5. After restart, connect device to the PC or laptop via USB, then launch the configurator software.

6. After launching the software, the device is recognized by selecting the appropriate virtual COM port. This can be done either automatically or manually.

After filling the input fields, the configuration must be downloaded into the device. It is advised to query the status of the device after configuration to check the signal strength, input and output states.

By obtaining valid signal strength and carrier info, it means that the device could successfully connect to a GSM network.

7. After downloading the configuration, the device should be disconnected from the PC or laptop, then it has to be disconnected from the internal battery and external power supply.
8. Then re-connect the power source and power on the device, and all functions must be checked. After configuration, further resetting the device will retain the configuration data.

***In the case the operating system does not recognize the connected device after driver installation, please check the system settings according to the following appendix !***

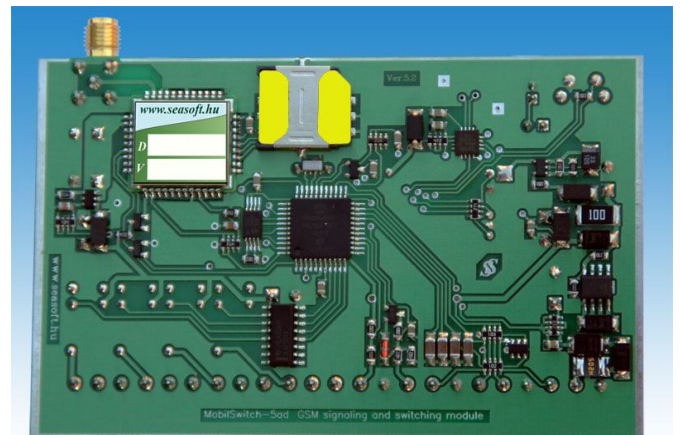

## 8. Specifications:

Power supply:	<b>10–30 Vdc</b>	GSM:	<b>Dual band</b>
Max. Current:	<b>270 mA</b>	Frequency:	<b>900/1800MHz</b>
Stdby current (relays on):	<b>70 mA</b>	Communication:	<b>SMS, voice</b>
Stdby current (relays off):	<b>30 mA</b>	Aerial conn.:	<b>SMA</b>
Analog input voltage:	<b>0-15V or 0-30 V</b>	Enclosure:	<b>Aluminium enclosure</b>
Operating temperature	<b>-30 - +70 C</b>	Dimensions:	<b>105 mm x 65 mm x 30 mm</b>

# Appendix: modifications of of setting of USB serial Com port in Windows-7 (step-by-step)

